

5c Installing the Printer Driver (Mac)

Connect the Publisher to your PC with your USB 2.0 Cable.

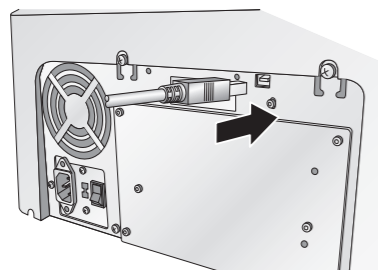

Add the printer via the Printer Setup Utility.

1. Open the Printer Setup Utility located in the Applications - Utilities folder.

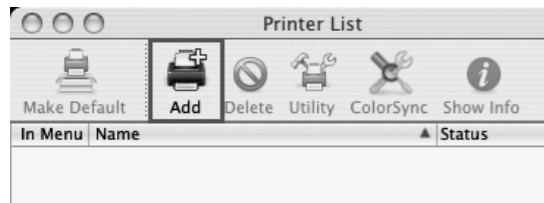

2. Click **Add**. Select the Disc Publisher PRO from the list of available printers. Click **Add** again.



6 Installing Ink Cartridges

- With the cover open, press the Cartridge Button  on the top of the Publisher to move the Ink Cartridge Carrier to the load position.
- Remove each ink cartridge from its packaging.
- Slowly remove the tape covering the cartridge's print head. **DO NOT TOUCH THE COPPER AREA!**
- Insert the ink cartridges into the carrier, copper end first and snap the cartridge cover in place. Insert the color in the right holder, monochrome black in the left cartridge holder. The cartridge labels are color coded to the cartridge covers.
- Close the Publisher's front cover.

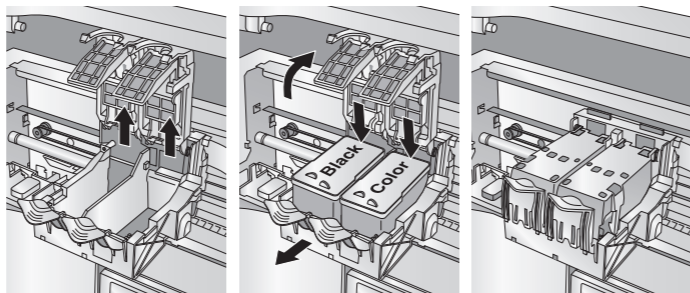

7 Aligning the Cartridges

If you are using a PC the Installer will prompt you to align the cartridge.

If you are using a Mac you will be prompted to align the cartridge before you print for the first time.

Note: An alignment print is required every time you install a new cartridge. The software will always prompt you to align the cartridges. Make sure there is an unprinted disc in the bin for this alignment.

8 Publishing a Disc

Congratulations, you are now ready to start Printing discs!

- For Instructions on printing a disc using a PC refer to section 3 in the User's Manual.
- For Instructions on printing a disc using a Macintosh refer to section 4 in the User's Manual.
- For help with problems printing discs using a PC or Macintosh please visit Primera's online Knowledgebase at <http://primera.com/knowledgebase.html>

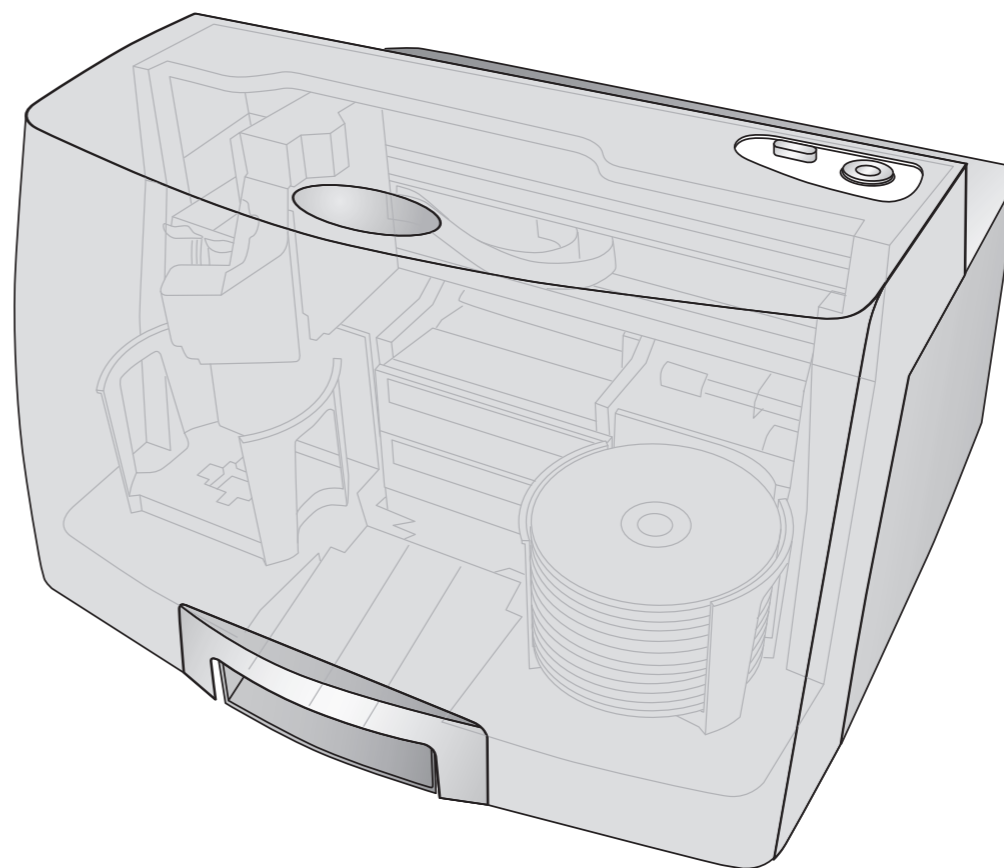
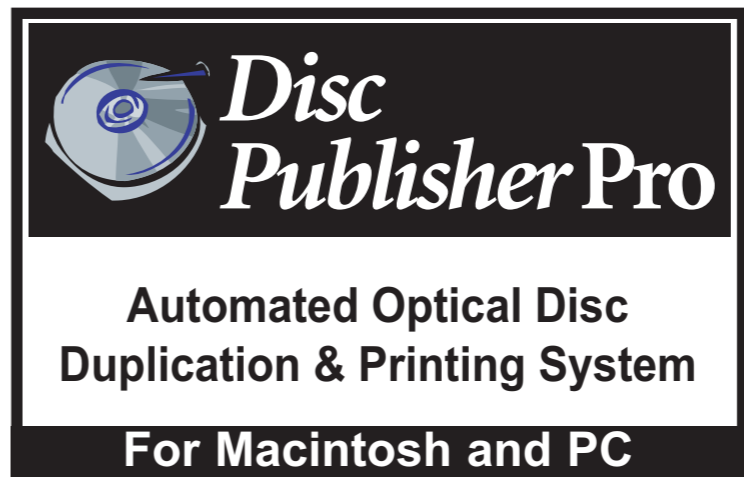

Quick Start

1 Unpack Your Publisher

- Optical Disc Publisher
- Plastic Input and Output Bins
- Power Cord
- One Three-Color (CMY) Ink Cartridge
- One Monochrome Black Ink Cartridge
- QuickStart Installer Disc (for use with both CD-R and DVD-R models)
- USB 2.0 Interface Cable
- This Quick Start Guide and Other Printed Information

Save the carton and packing materials. They will come in handy later if you ever need to transport the Publisher and/or any of its parts and accessories.

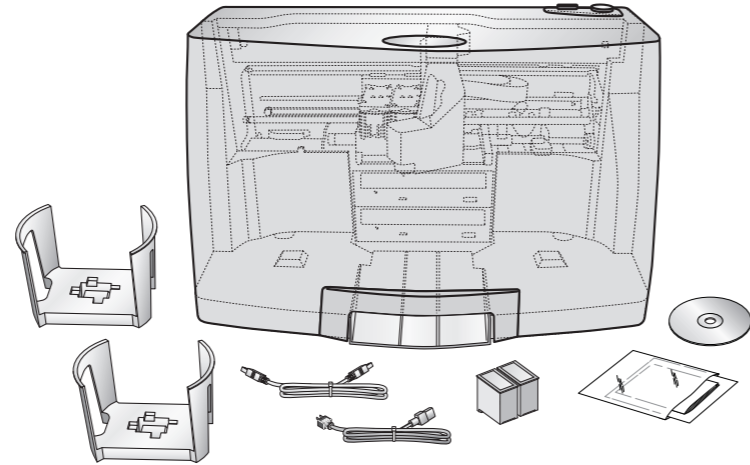

2 Installing the Software

PC

1. Place the Installer CD in your CDROM Drive. The Installer application will automatically launch in a few moments.
2. Click **Standard Install** to begin the installation. You may follow either the steps shown in this Quick Start or the steps shown in the installer to complete the installation.

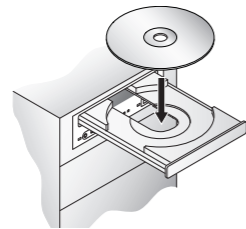

Note: If the Installer does not start, open My Computer on your desktop. Double-click the icon of the appropriate CD drive containing the Software Installer disc. Double-click *Installer.exe*.

Mac

1. Insert the Disc Publisher Installation CD-ROM in your system's CD-ROM drive.
2. Double-click the CD-ROM icon.
3. Double-click on the **Disc Publisher Installer.mpkg** file icon. Follow the on-screen instructions.

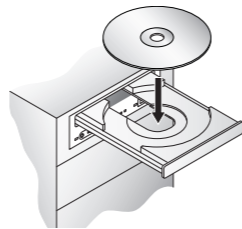

3 Applying Power

Important! Be sure you have removed the packing tape and cardboard shipping insert before applying power.

- Locate the power cord supplied with your Publisher.
- Plug the adapter into a surge protected outlet, and plug the power plug into the power port on the rear panel of the Publisher.
- Turn on the power switch. Wait for the LED lights to stop flashing (30 seconds).

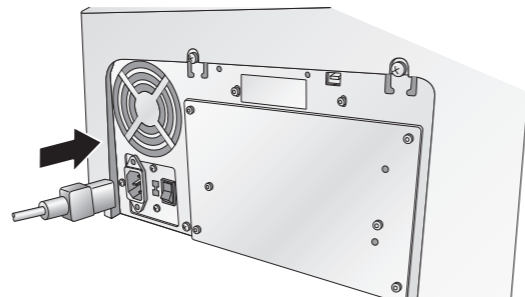

4 Loading Media (Discs)

NOTE: Your Publisher can print directly onto virtually any brand of **inkjet printable-surface** CD/DVD media. Due to the wide variety of printable-surface CD/DVD media, you may find that certain brands of discs provide higher print quality than others. For maximum print quality, use CD/DVD media authorized by Primera.

Refer to the following steps when loading discs in to the Publisher:

- Open the front cover of the Publisher
- The Publisher will automatically position the cartridge carrier and Robotic Disc Transporter to the center position allowing for easy access to the bins.

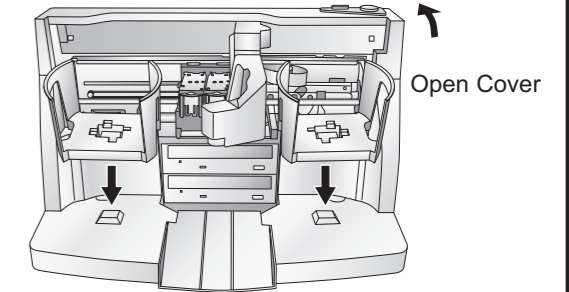

- Load the Input Bin (the bin located on the right-hand side of the Publisher) with up to 50 blank discs and place the bins on the mounting pegs.

5a Installing the Printer Driver (Windows XP)

Connect the Publisher to your PC with your USB 2.0 Cable.

After a few moments, Windows will tell you it has found new hardware and is looking for software to install it.

Select "**Install the software automatically**" and follow through the wizard to complete the installation.

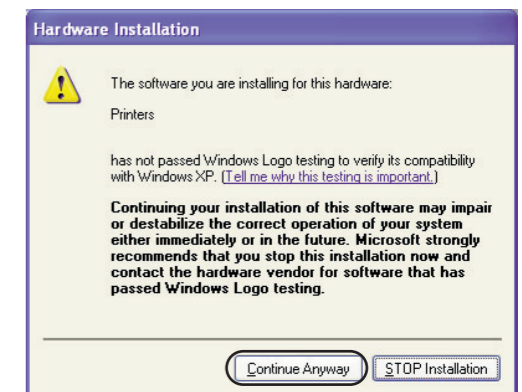
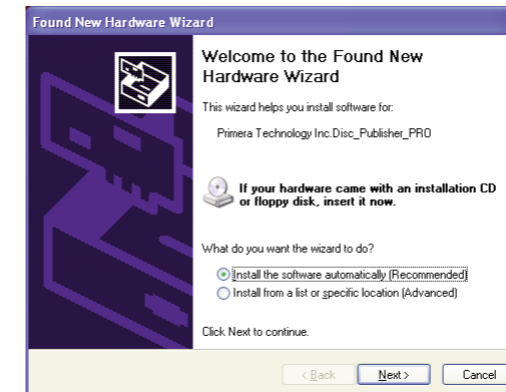
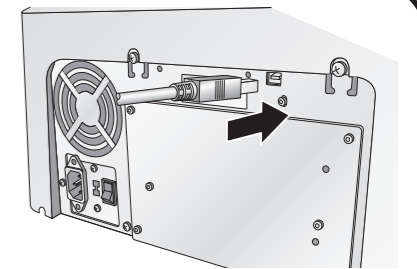

You will be prompted that the software has not passed Windows Logo Testing. You must click **Continue Anyway** to finish the installation.

5b Installing the Printer Driver (Windows Vista)

Click the "**Install Driver**" button when prompted to do so by the installation disc.

Files will begin to copy to your hard drive.

You will be prompted that Windows can't verify the publisher of this driver software. Click **Install the driver software anyway**.

Finally, connect the Publisher to your PC with your USB 2.0 Cable.

